

AMREL®

# ROCKY DK10



**User's Guide**  
FULLY RUGGED  
TABLET COMPUTER

## Notice

Copyright© 2013, American Reliance Inc., dba AMREL ®. All rights reserved.

No part of this publication may be reproduced and modified without the written permission of AMREL.

AMREL reserves the right to make changes in the products or the product specifications without any prior notice. Customers are advised to contact AMREL for updated product information.

AMREL makes no representations or warranties, either expressed or implied, with respect to the contents hereof and specifically disclaims any warranties for the correctness of this book, nor any license grant of AMREL's patents or intellectual properties.

AMREL assumes no liability for customer's loss or damage caused by using this document.

## Trademarks

All other brand and product names are trademarks or registered trademarks of their respective companies.

## Regulatory Information/Disclaimers

Installation and use of this computer must be in strict accordance with the instructions included in the user documentation provided with the product. Any changes or modifications (including the antennas) made to this device that are not expressly approved by the manufacturer may void the user's authority to operate the equipment.

The manufacturer is not responsible for any radio or television interference caused by unauthorized modification of this device, or the substitution of the connecting cables and equipment other than manufacturer specified. It is the responsibility of the user to correct any interference caused by such unauthorized modification, substitution or attachment. Manufacturer and its authorized resellers or distributors will assume no liability for any damage or violation of government regulations arising from failing to comply with these guidelines.

## FCC (Federal Communications Commission) Statement

This equipment has been tested and found to comply with the limits for a Class-B digital device pursuant part 15 of the FCC Rules. These limits are designed to provide reasonable protection against harmful interference in a residential installation.

This equipment generates, uses, and radiates radio frequency energy. If not being installed and used in accordance with the instructions, it may cause harmful interference to radio communications. However, there is no guarantee that interference will not occur in a particular installation. If this equipment does cause harmful interference to radio or television reception, which can be determined by turning the equipment off and on, the user is encouraged to try to correct the interference by one or more of the following measures:

- Re-orient or relocate the receiving antenna.
- Increase the separation between the equipment and receiver.
- Connect the equipment into an outlet on a circuit different from that to which the receiver is connected.
- Consult the dealer or an experienced radio/TV technician for help.

This device complies with Part 15 of the FCC Rules. Operation is subject to the following two conditions:

- This device may not cause harmful interference.
- This device must accept any interference received, including interference that may cause undesired operation.



### **FCC Caution:**

*To assure continued compliance, any changes or modifications not expressly approved by the party responsible for compliance could void the user's authority to operate this equipment. (Example - use only shielded interface cables when connecting to computer or peripheral devices).*

## CE

Products with the CE Marking comply with both the EMC Directive (2004/108/EC) and the Low Voltage Directive (2006/95/EC) issued by the Commission of the European Community.

Compliance with these directives implies conformity to the following European Norms:

**EN55022** CISPR 22 Radio Frequency Interference

**EN55024** EN61000-4-2, EN61000-4-3, EN61000-4-4, EN61000-4-5, EN61000-4-6, EN61000-4-8, EN61000-4-11, EN61000-3-2, EN61000-3-3, Generic Immunity Standard

**LVD** EN 60950-1: 2006+ A11: 2009+ A1: 2010+ A12: 2011  
IEC 60950-1: 2005+AM1:2009

## R&TTE (CE) Manual Regulatory Requirement

### WLAN - IEEE 802.11a/b/g/n

802.11a/b/g/n Restrictions:

European standards dictate maximum radiated transmit power of 100mW EIRP and frequency range 2.400-2.4835 GHz. In France, the equipment must be restricted to the 2.4465-2.4835 GHz frequency range and must be restricted to indoor use.

## CE Declaration of Conformity



It is confirmed to comply with the requirements set out in the Council Directive on the approximation of the laws of the member states relating to Electromagnetic Compatibility Directive (2004/108/EC), Low-voltage Directive (2006/95/EC) and the procedures given in R&TTE Directive (99/5/EC).

The equipment was passed, and the equipment test was performed according to the following European standards:

**EN 300 328 V1.7.1 (2006)**

**EN 301 893 V1.6.1 (2011)**

**EN 301 489-1 V1.9.2 (2011) / EN 301 489-17 V2.2.1 (2012)**

**EN62311 2008**

**EN300440-1 V1.6.1 2010**

**EN300440-2 V1.4.1 2010**

**UL, TÜV**

AC Adapter (TÜV includes **LVD EN60950**)

## Power Conservation

This tablet computer consumes less power compared to conventional consumer computers. The power consumption may be further reduced by properly configuring the Power Management Setup.

It is recommended that the power saving features be enabled even when not running on battery power. Power Management features can conserve power without degrading system performance.

## Power Safety

There are specific power requirements for your tablet computer:

- Only use an approved AC adapter designed for this tablet computer.
- There is a 3-prong grounded plug for the AC adapter. The 3<sup>rd</sup> prong is an important mechanism for ensuring product safety. Please do not neglect the importance of this mechanism. If you are unable to access a compatible outlet, please hire a qualified electrician to install a compatible outlet for you.
- When unplugging the AC power cord, please make sure to disconnect the cord by pulling from the plug head instead of pulling from the wire to prevent wire damage.
- Make sure the power outlet and any other extension cord(s) you use can support the total current load of all the connected devices.
- Before cleaning the tablet computer, please make sure it is disconnected from any external power source.



### **Warning**

*Before any upgrade procedures, make sure the power is turned off, and all the cables are disconnected (including telephone lines). Also, it is advisable to remove your battery to prevent your tablet computer from accidentally turning on.*

## Battery Precautions

- Only use batteries designed for this tablet computer. Using incompatible battery types may cause explosion, leakage or damage to the computer.
- Do not remove the battery from the computer while the computer is powered on.
- Do not continuously use a battery that has been dropped, or that appears damaged (e.g. bent or twisted) in any way. Even if the computer is able to continuously work with a damaged battery, the circuit damage may occur and possibly cause fire.
- Always use the charger designed for this computer to recharge the battery. Incorrect recharging may cause the battery to explode.
- Do not try to service a battery by yourself. For battery service or replacement, please contact your service representatives.
- Please dispose of damaged battery promptly and carefully. Explosion or leakage may occur, if the battery is exposed to fire, improperly handled or discarded.



### **Battery Disposal & Caution**

*The product that you have purchased contains a rechargeable battery. The battery is recyclable. At the end of its service life, under various state and local laws, it may be illegal to dispose of this battery into the municipal waste stream. Check with your local solid waste officials for details in your area for recycling options or proper disposal. Danger of explosion may possibly occur, if the battery is incorrectly replaced. Replace only with the same or the equivalent battery recommended by the manufacturer. Discard the used battery according to the manufacturer's instructions.*

## Environmental Information, Material Safety & Recycling

All materials used in the manufacturing of this equipment are recyclable or environmentally friendly. Please recycle the packing materials in accordance with local regulations at the end of the product's service life.

### Notice:

- The equipment may contain insignificant amount of hazardous substances for health and environment below control level.
- To avoid spreading such substances into the eco system and to minimize the pressure on the natural environment, you are encouraged to reuse or recycle most of the materials in a safe way after the product's service life.
- For more information on collection, reuse and recycle of materials, please consult local or regional waste administrations for more information. You can also contact your dealer for more information on the environmental details of the equipment.
- The symbol of the crossed out wheeled bin indicates that the product (electrical and electronic equipment) should not be placed in municipal waste. Please check local regulations for disposal of electronic products.





# TABLE OF CONTENTS

<b>CHAPTER 1 - GETTING STARTED.....</b>	<b>1</b>
UNPACKING .....	1
WORKPLACE .....	2
ENVIRONMENTAL RATINGS .....	2
RUGGEDNESS .....	3
APPEARANCE OVERVIEW .....	4
READY FOR USE.....	10
<b>CHAPTER2 - OPERATING INFORMATION.....</b>	<b>12</b>
START USING YOUR TABLET COMPUTER.....	12
STOP USING YOUR TABLET COMPUTER .....	13
WORKING WITH POWER BUTTON (HEATER KIT) .....	114
INSTALLING OPERATING SYSTEM .....	15
USING INDICATORS AND BUTTONS .....	16
USING HARD DISK DRIVE (HDD) / OPTIONAL SOLID STATE DRIVE (SSD).....	17
USING SD CARDS .....	17
USING EXPRESSCARDS .....	18
INTEL® RAPID START TECHNOLOGY .....	19
USING THE TOUCH SCREEN .....	20
OPERATING WIRELESS DEVICES.....	22
USING DOCKLIGHT DL10 (OPTION) .....	30
<b>CHAPTER3- MANAGING POWER .....</b>	<b>32</b>
AC ADAPTER .....	32
BATTERY .....	33
ACPI SUPPORT .....	35
USB FAST CHARGING .....	36
<b>CHAPTER 4 - BIOS SETUP.....</b>	<b>37</b>
MAIN MENU .....	37
ADVANCED MENU .....	38
SATA CONFIGURATION SUB-MENU .....	40
SATA CONFIGURATION SUB-MENU SELECTIONS .....	40
USB CONFIGURATION SUB-MENU .....	41
USB CONFIGURATION SUB-MENU SELECTIONS .....	41
IT8783F SUPER IO CONFIGURATION SUB-MENU.....	42
RF DEVICE CONTROL CONFIGURATION SUB-MENU.....	43
EC THERMAL CONTROL SUB-MENU.....	44
CHIPSET MENU .....	45
CHIPSET MENU SELECTIONS .....	45
PCH-IO CONFIGURATION SUB-MENU .....	46
BOOT MENU .....	47

---

BOOT MENU SELECTIONS .....	47
SECURITY MENU .....	48
SAVE & EXIT MENU .....	49

**CHAPTER 5 – DRIVERS AND APPLICATIONS ..... 50**

CHIPSET .....	50
VGA .....	51
AUDIO .....	51
INTEL ME .....	52
INTEL RAPID STORAGE TECHNOLOGY .....	52
WIRELESS POWER MANAGER.....	53
TOUCH SCREEN .....	53
USB3.0 .....	54
RICOH SD CONTROLLER.....	54
TURBO BOOST MONITOR .....	55
GIGABIT LAN .....	55
2ND GIGABIT LAN (OPTION) .....	56
WiFi (OPTION).....	57
BLUETOOTH (OPTION) .....	57
GPS (OPTION).....	58
WWAN (OPTION) .....	59
TPM (OPTION).....	60

**CHAPTER 6 – SPECIFICATIONS..... 61**

PLATFORM .....	61
CPU .....	61
PCH .....	61
MEMORY .....	61
TOUCH SCREEN .....	61
HARD DISK DRIVE (HDD)/SOLID STATE DRIVE (SSD).....	61
BUTTONS.....	61
AUDIO .....	61
I/O PORTS .....	62
DIMENSIONS AND WEIGHT.....	62
POWER.....	63
ENVIRONMENTAL, SAFETY & EMC.....	63
MATERIALS AND RECYCLING .....	64

**CHAPTER 7 – OPTIONAL DEVICES ..... 65**

COMMUNICATION.....	65
MEMORY CARD .....	65
2ND BATTERY .....	65
SECURITY .....	65
DOCKLIGHT DL10 .....	66
MULTI-BATTERY CHARGER .....	66

EXTERNAL USB KEYBOARD .....	67
MINI KEYBOARD KBD .....	68
STAND UNIT .....	69

**CHAPTER 8 – MAINTENANCE AND SERVICE..... 70**

CLEANING.....	70
TROUBLESHOOTING.....	70
RMA SERVICE .....	71

# Chapter 1 - Getting Started

## Unpacking

The following components come with your computer. If anything is missing or damaged, please notify the dealer immediately.

- Computer unit
- AC Adapter
- AC Power Cord
- Utility DVD
- Quick Guide
- Carrying Bag

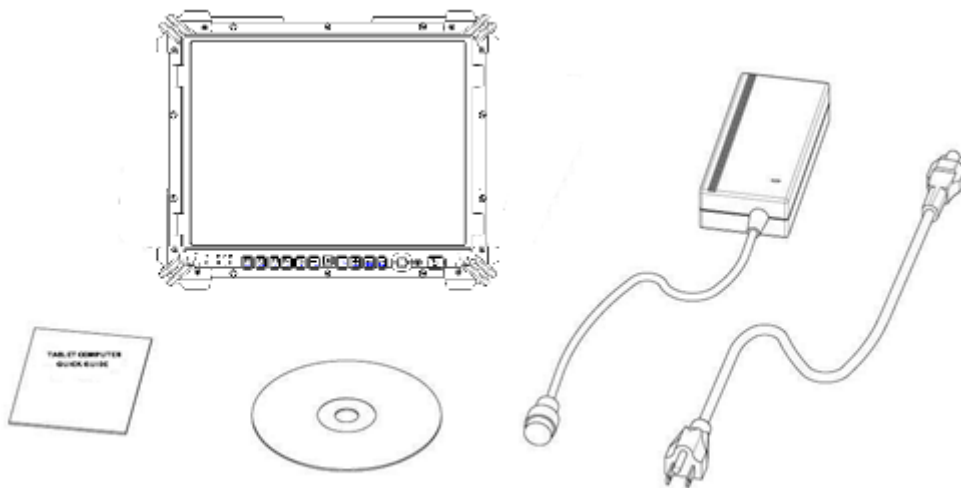

---

## Workplace

A clean and moisture-free environment is preferred. Make room for air circulation. Remember to avoid areas from:

- Sudden or extreme changes in temperature.
- Extreme heat.
- Strong electromagnetic fields (Near television set, motor rotation area, etc.).
- Dust or high humidity.

If this tablet computer is required to work in a hostile environment, please maintain your tablet computer regularly by cleaning dust, water, and etc. to keep it in an optimal operating condition.

## Environmental Ratings

Operating Temperature: I: 0 ~ 40 °C (32 ~ 104 °F)

M: -20 ~ 50 °C (-4 ~ 122 °F)

Storage Temperature: -40 ~ 70°C (-40 ~ 158°F)

Humidity: Operating/Storage: 5~95% (non-condensing)

Altitude: Operating/Storage: 15,000/ 40,000 feet (4572 /12,180 meters)

---

## **Ruggedness**

The computer is designed with rugged features such as vibration, shock, dust, and rain/water protection. However, it is still necessary to provide appropriate protection while operating in harsh environments.

NEVER immerse the computer in water. Doing so may cause permanent damages. Drop may cause parts break or permanent damages.

The D-sub connector cap is for dust and shock protection only. The connector itself is sealed internally. Other I/O ports and devices must have caps tightly closed or cable inlets sealed while exposed to water or dust.

All connectors will corrode if exposed to water or moisture. Corrosion is accelerated if the power is ON. Please take proper measures in cable connection to avoid water entering into connectors.

The DC jack and cables are sealed and may be operated with water splashing while attached. All port covers should be in place when no cable is attached.

Appearance Overview

**Note:**  
 ➤ The following illustrations show the tablet mounted on optional devices, which may not appear on your devices.

Front

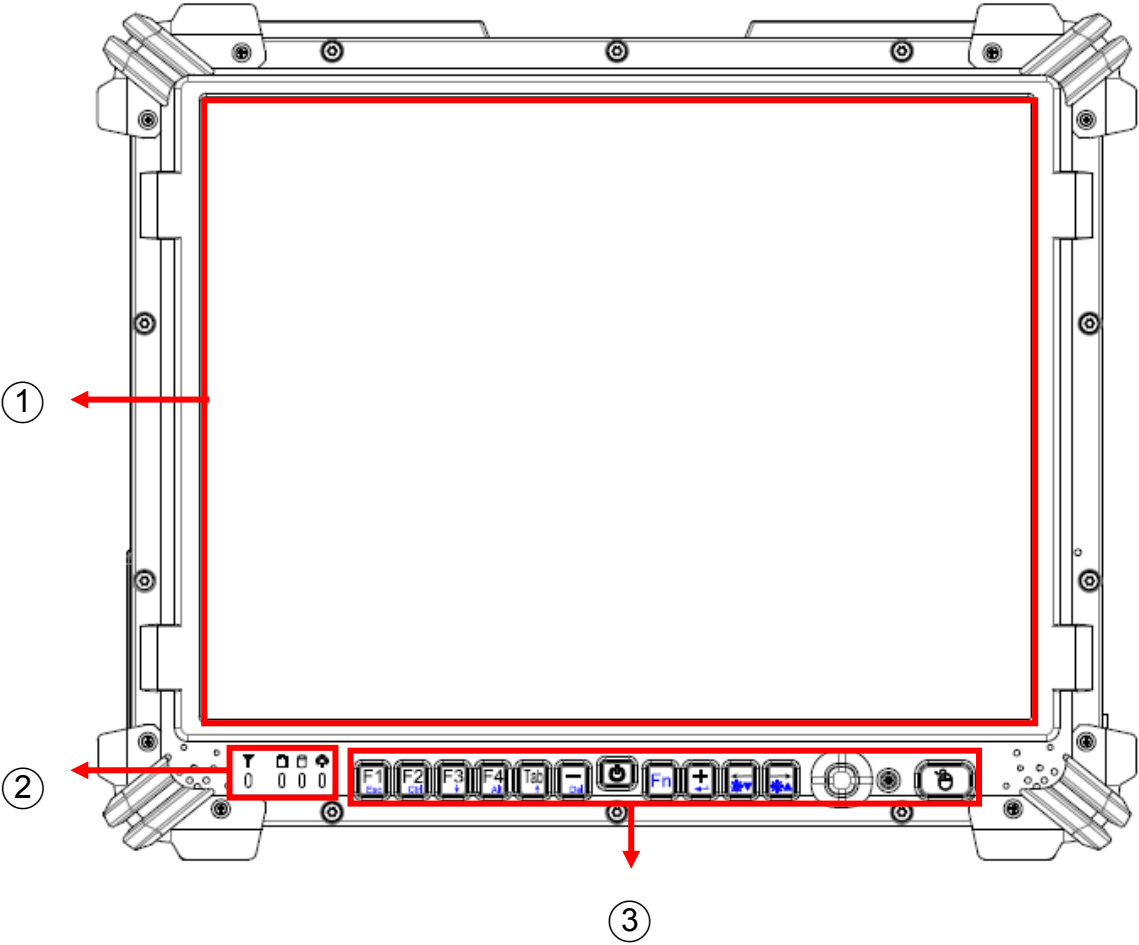

- 1. Touch Screen
- 2. LED Indicators
- 3. Buttons (Left to Right)

Button Layer 1:	Button Layer 2:
Function Key F1	Esc Key
Function Key F2	Ctrl Key
Function Key F3	Down Arrow Key
Function Key F4	Alt Key

Tab Key	Up Arrow Key
Minus (-) Sign	Delete Key
Power Button	
	Fn Key
Plus (+) Sign	Enter Key
Left Arrow Key	Decrease Brightness
Right Arrow Key	Increase Brightness
Track Pointer	
Function Backlight	
Left Mouse Button	

For more information on Buttons and Indicators, please refer to [Using Indicators and Buttons](#) section.



## Rear

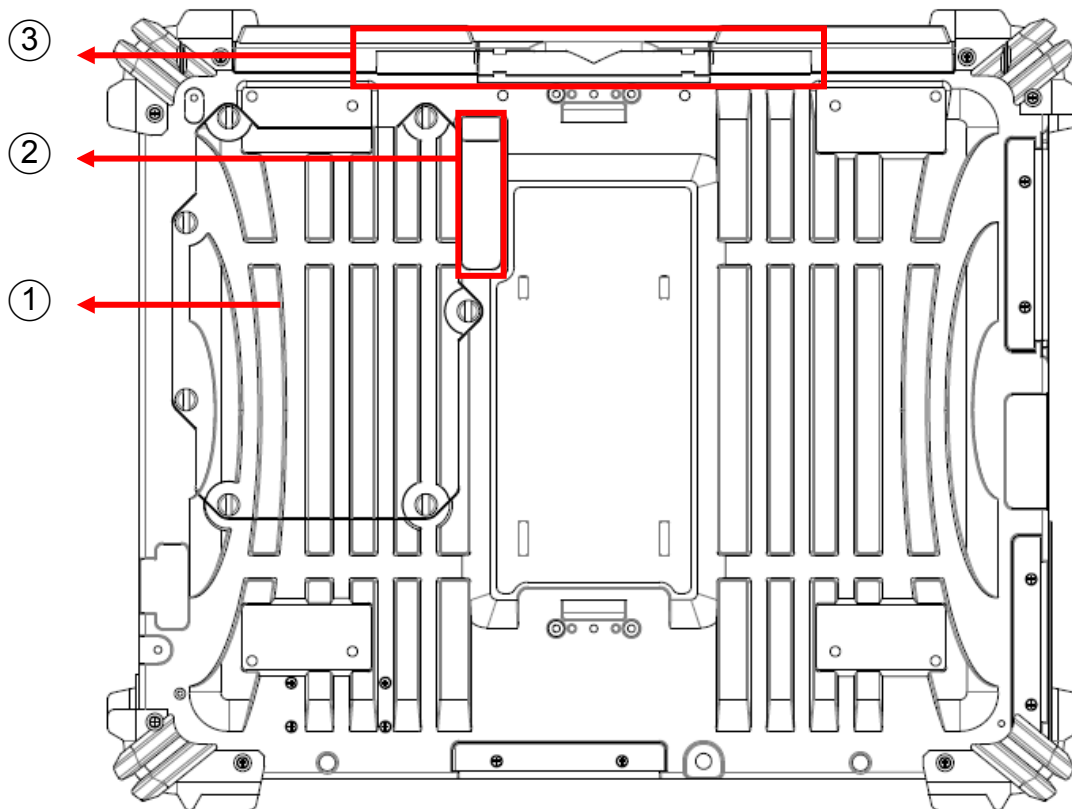

1. HDD or optional SSD
2. Secondary battery connector
3. Stylus holder

Left

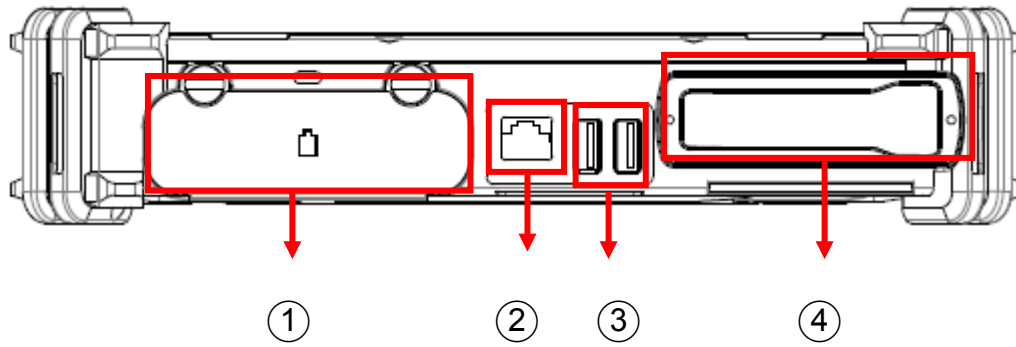

1. Battery
2. GLAN RJ45
3. USB 3.0 x 1 (Left)  
USB 2.0 with Fast Charger x 1 (Right)
4. Multi Bay: ExpressCard (Top)  
SIM Card + SD Card (Bottom)

Right

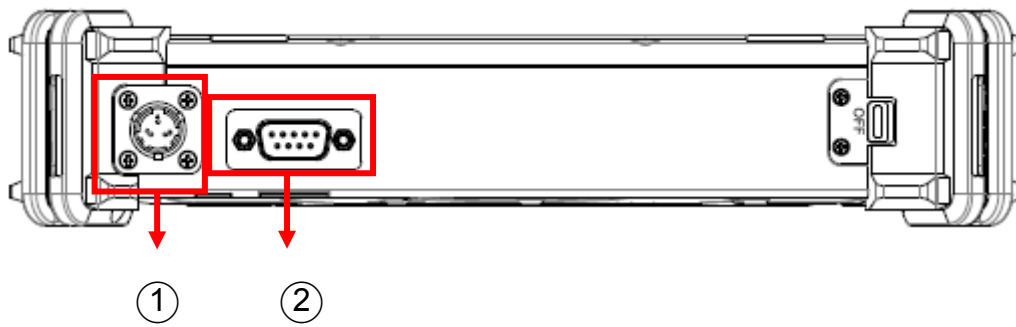

1. DC jack (2 pin for DK10I, 3 pin for DK10M)
2. Serial port DB9 (COM1, Default: RS232)

**Note:**

- The External COM1 port default is RS232, and it can be selected by BIOS (RS232/RS422/RS485). Please refer to [IT 8783F Super IO Configuration Sub-Menu](#) section for more information.

**Top**

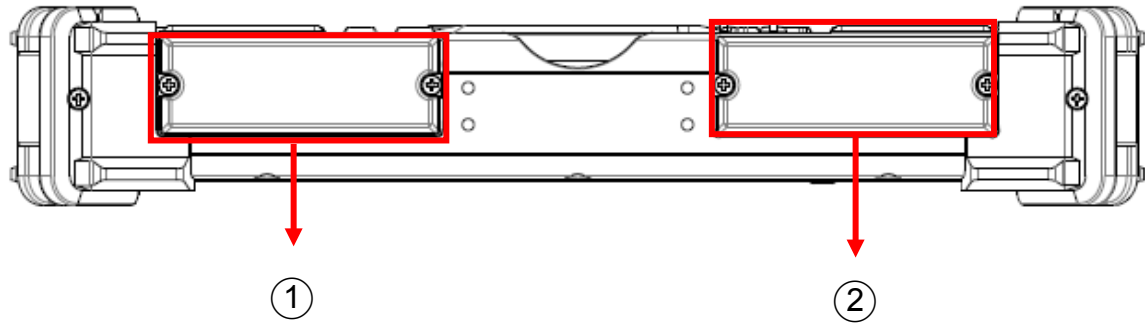

1. Optional WWAN/Wi-Fi Antenna
2. Optional Wi-Fi/BT/GPS Antenna

**Bottom**

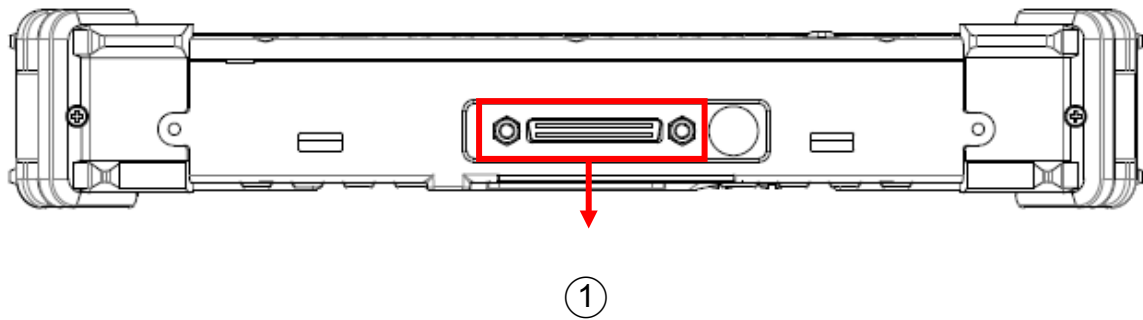

1. Docking connector

## Ready for Use

After taking a quick look at your tablet computer, the following illustrations will get you ready for using it.

### 1. Mounting the Battery

- A. Mount the battery into the battery bay.      B. Close the cover, turn clockwise and lock firmly with a flat-head screwdriver or a coin.

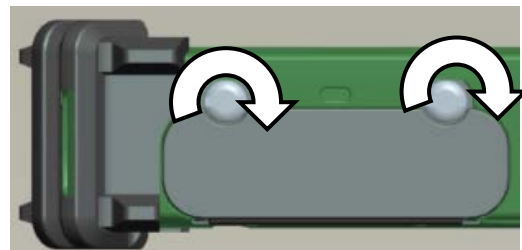
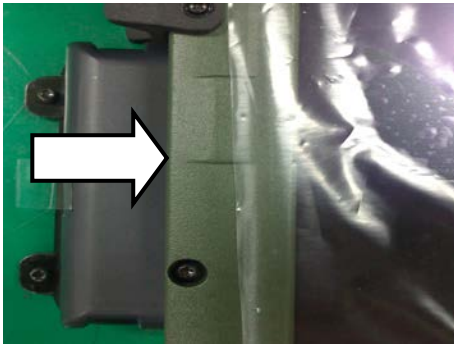

### 2. Connecting the AC Adapter

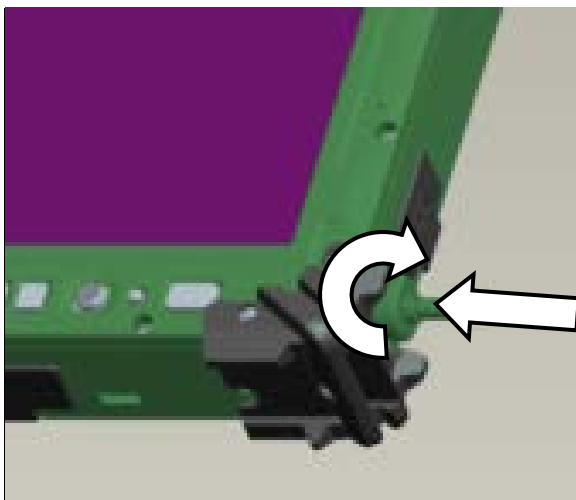

- A. Insert the DC Jack and firmly lock the connector clockwise.



- B. Plug the AC cord into the AC adapter.  
C. Plug the AC power plug into an electrical outlet.

### 3. Turning ON the Power

- A. Make sure the battery is securely mounted. Connect all power cords properly.
- B. Turn on the power of your tablet computer by pressing the “**Power Button**”.

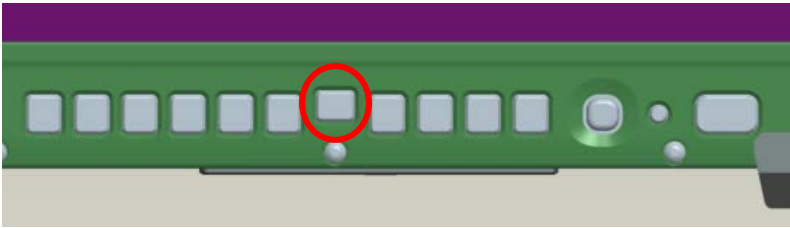

Press  to turn on the power of your tablet computer.

**Note:**

- The power is able to turn ON without any battery mounted once all the power cords are connected.

### 4. Turning Off the Power

Directly tap “Shut down” from your OS to turn OFF the power of your tablet computer. If your tablet computer stops responding, press and hold the power button to “Force Shut down” your tablet computer.

**Note:**

- Directly turning off the power of your tablet computer by “Force Shut down” will cause all unsaved data to be lost and is not recommended.

## **Chapter2 - Operating Information**

### **Start Using Your Tablet Computer**

Always turn on your tablet computer by using the power button. This is the standard operating procedure to start using your tablet computer. After turning on the power of your tablet computer, it will start with the Operating System (OS) installed.

### **Boot Up**

When you turn on the power, your computer will start to load the OS into the system memory. This start-up procedure is called “boot up”.

### **Power On Self-Test (POST)**

Each time your computer is turned on, the BIOS will automatically perform a self-test of CPU, memory, hardware devices, and so on.

## Stop Using Your Tablet Computer

Each time when you finish working with your tablet computer, there are several ways to stop your tablet computer from operating.

### Shut down

Directly tap “Shut down” from your OS to turn OFF the power of your computer. Before shutting down, please do remember to save any unfinished works and close your applications to prevent your HDD/SSD from suffering possible data loss or damage. “Shut down” will turn OFF power of your computer. If you want to start your computer again, you need to turn it ON again by pressing the power button.

### Sleep

Under “Sleep” mode, the system will temporarily save your work into the computer’s RAM. If you want to start your computer again, please press the power button to resume. You can enter this mode by directly tapping:

**Swipe in from the right edge of the screen, and then tap “Settings” => Tap “Power” => Tap “Sleep”** under Windows 8.

### Hibernate

Under “Hibernate” mode, the system will save your work into HDD. If you want to start your tablet computer again, you need to press the power button. You can enter “Hibernate” mode by pressing the power button, or by directly tapping:

**Swipe in from the right edge of the screen, and then tap “Settings” => Tap “Power” => Tap “Hibernate”** under Windows 8.

### Force Shut Down

In the event that your tablet computer hangs or stops responding, you can perform a force shut down by pressing and holding the power button for 4~5 seconds. Please note that any unsaved work or data will be lost this way.



## Working with Power Button (Heater Kit)

Your tablet computer is equipped with a heater kit to enable work under low temperature. The heater will heat up the HDD to the temperature set by the user before booting the system. Also, the heater will constantly monitor HDD temperature. Once the temperature becomes lower, the heater will heat up again to maintain the temperature set by user.

### Note:

- When ambient temperature is under +41 °F (5 °C) (the default setting for your tablet computer), the system may not boot up immediately. System will beep with HDD LED light flashing orange to indicate that the heater is in operation. The LED will blink faster as the HDD temperature approaches operational temperature. After 5~15 minutes, the system will boot up automatically.
- In emergency situations, you can skip the heating process by pressing and holding the power button for 9~11 seconds then release. The speaker will beep with a special sound to signify that the heating process has been skipped (Please note that not all devices are guaranteed to work properly in this case).
- Press the power button again during the heating process will shut down the computer.

The following is a list of functions associated with your tablet computer's power button:

1. Press and hold for 12 seconds, then release:  
USB port is enabled and you can set a new value in Heater AP.
2. Press and hold for 9 ~ 11 seconds:  
The system will skip heating process and force boot up.
3. Press and hold for 5 ~ 8 seconds:  
Enable/Disable the sound of Heater.
4. Press and hold the power button for 4 seconds under OS:  
Shut down the system.
5. Press the power button:
  - a. Power on the system.
  - b. Force Shut Down (If pressed while the heating process is underway).
  - c. Sleep/Hibernate (Dependent on OS settings).

## Installing Operating System

Your computer is designed to operate with Microsoft Windows® 7 or 8 32 / 64-bit Operating System. Please connect your computer with an external USB-interface drive, such as an ODD or a USB thumb drive, and start the OS installation.





### Note:

- *A USB hub may be required during installation to connect with an external USB-interface ODD and Keyboard, as the System USB port may not supply enough power. Please connect your USB hub with extra power supply to complete the installation.*

## Using Indicators and Buttons

Your tablet computer is designed with backlight buttons for easy and quick operations. Also, each LED indicator shows different meanings. The description of each LED indicator and button functions are provided for your operational reference.

### LED Indicators

LED Indicator	Description
	<b>Power Indicator:</b> Green (Power); Flashing Red (S3: Sleep); Flashing Green (Battery power is lower than 10%)
	<b>Charger Indicator:</b> Orange
	<b>HDD Indicator (Dual LED):</b> Green (HDD); Orange (Heater)
	<b>Wireless Devices Indicator:</b> Blue

Some of the functions of the first layer buttons include:

Button Layer 1	Description
F1	Function Key F1/ BIOS General Help
F2	Function Key F2 / BIOS Previous Values
F3	Function Key F3 / BIOS Optimized Defaults
F4	Function Key F4 / BIOS Save & Exit
Tab	Tabulation
Minus (-) Sign	BIOS change option
Plus (+) Sign	BIOS change option
Left Arrow (←) Key	BIOS Select screen
Right Arrow (→) Key	BIOS Select screen

To perform 2<sup>nd</sup> layer combinational keystroke functions (keystroke functions printed in **blue**), press and hold the **[Fn]** key, then press the corresponding key combinations.

A list of useful combinational button functions is provided below for operational reference:

Button Layer 2	Description
[Fn] + [Esc]:	Escape Key.
[Fn] + [Ctrl]:	Control Key
[Fn] + [↑]:	Up Arrow Key
[Fn] + [↓]:	Down Arrow Key
[Fn] + [Alt]:	Alt Key
[Fn] + [☀️▲]:	Increases LCD brightness
[Fn] + [☀️▼]:	Decreases LCD brightness
[Fn] + [↵]:	Enter Key

## Using Hard Disk Drive (HDD) / Optional Solid State Drive (SSD)

Your tablet is equipped with 2.5" SATA II Hard Disk Drive (HDD), or optional Solid State Drive (SSD) for data storage. HDD/SSD is user removable, providing convenience and security. It can **ONLY** be removed while power is **OFF**.

**Note:**

- *Avoid dropping your HDD/SSD module. Do not expose it directly to high temperature, high humidity, and other hazardous environment. NEVER try to disassemble the module. Static discharge may destroy your device and data. Always pick up the module by touching the case only.*

## Using SD Cards

Your tablet computer is equipped with a SD card slot. The SD card slot supports SDHC, SDXC, UHS-1. To avoid damages caused by misinsertion, please insert your SD card into the card slot properly with the connectors facing **down**, as shown below.

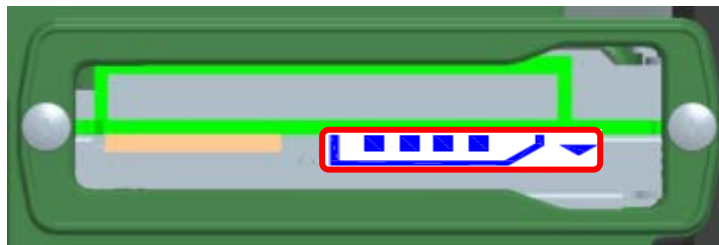

## Using ExpressCards

The computer supports 2.1 in or 1.3 in (54 mm or 34 mm) wide ExpressCard. You can install an ExpressCard while the computer is running. The computer automatically detects the card.

### To install an ExpressCard:

- Hold the card with the top side of the card.
- Slide the card into the slot until the card is completely seated in its connector.

### To remove an ExpressCard:

Press the card and remove the card gently.

The following illustration shows the insertion of ExpressCard 2.1 in:

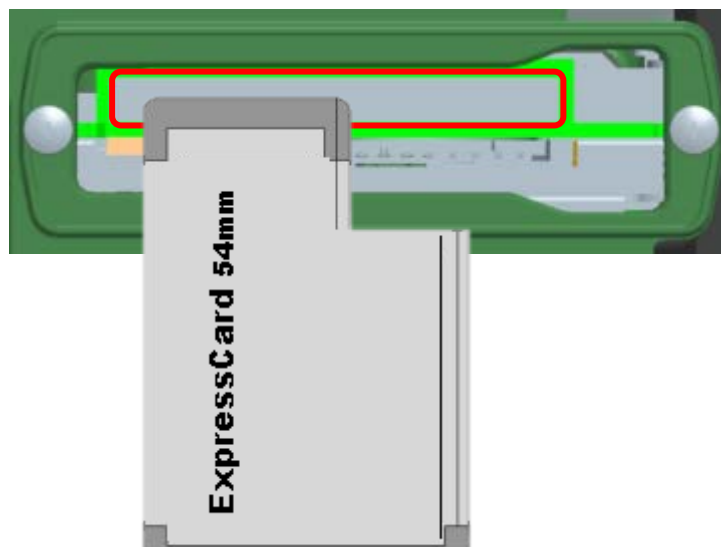

## Intel® Rapid Start Technology

Your tablet computer can operate Intel® Rapid Start Technology when SSD is installed. This technology enables your system resume time not only to be as fast as wake-up time from S3 (Sleep) mode, but also to be more energy saving.

Before using Intel Rapid Storage Technology, please check the following system requirements:

### System Requirement:

- Intel QM67 Express Chipset-based desktop board
- Intel Sandy Bridge i7-2610UE
- Solid State Drive (SSD)
- Operating system: Microsoft Windows® 7 or 8 (32- or 64-bit edition)

#### Note:

- *Intel® Rapid Storage Technology Driver should be installed and can be found in Utility DVD.*
- *Please use “Intel® Rapid Start Technology User Guide,” instead of “Intel® Rapid Start Technology User Guide for UEFI Mode,” to setup the function. You can find the User Guide from Intel official website.*
- *Please remember to enable Rapid Start Technology from BIOS Advanced Menu.*
- *To cancel the Rapid Start Technology, please disable the function from BIOS Advanced Menu.*

## Using the Touch Screen

Your tablet computer is equipped with a highly sensitive touch screen, allowing you to navigate on the touch screen easily without using other external devices. Before using the touch screen, please follow the instructions below to calibrate your stylus pen for a more precise positioning:

1. Tap “Configure” to start.

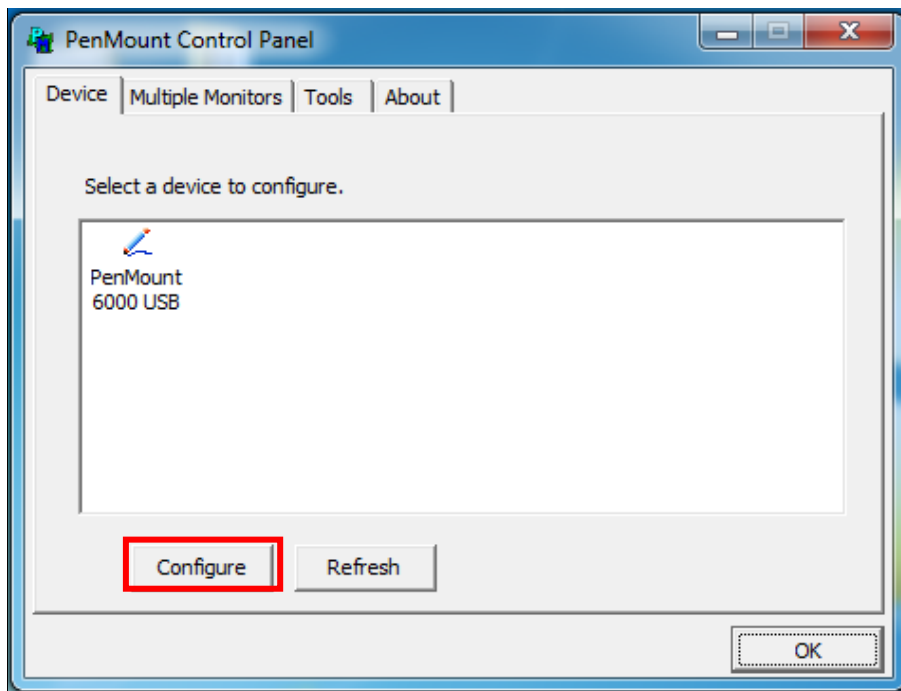

2. Use “Standard Calibration” and follow the instructions.

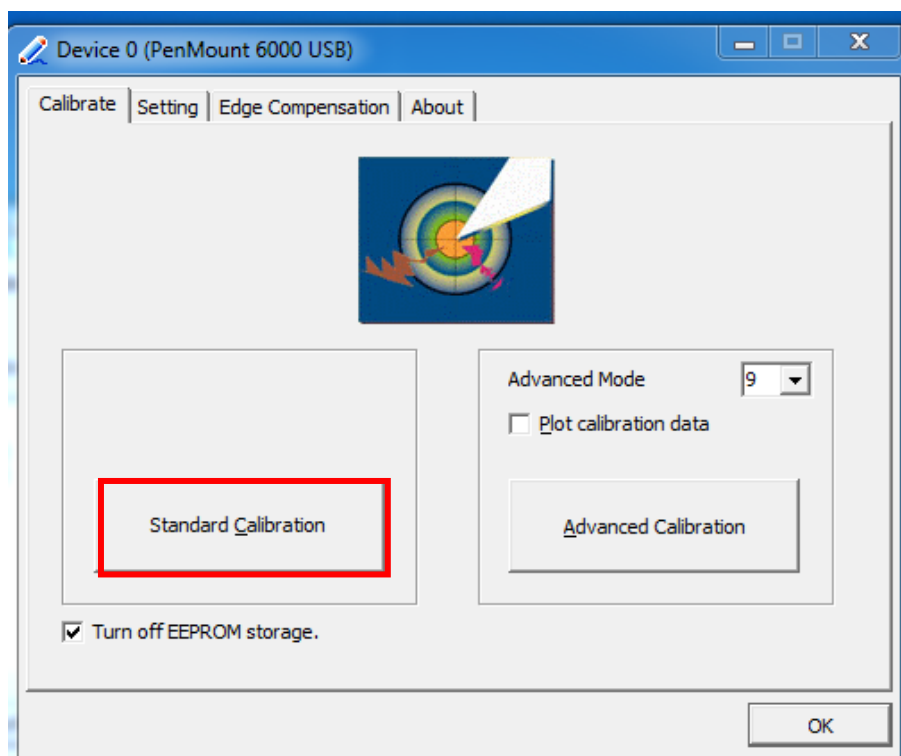

A stylus pen is provided for operating the touch screen. A list of operating tips is provided below to help you operate the touch screen more effectively with your stylus pen.

Desired Operation	Stylus Action
Single Click	Tap the touch screen once with your stylus pen.
Double Click	Quickly tap the touch screen twice with your stylus pen.
Drag and Drop	To drag, tap and hold the object gently with your stylus pen. Without moving your stylus pen away from the touch screen, move your stylus pen until you reach your destination. To drop, simply release your stylus pen from the touch screen.
Right Click	Press and hold your stylus pen on one point of the touch screen for 2~3 seconds. This is the same as using the right click of a mouse.

**Note:**

- To adjust the brightness of the screen, please refer to [Using Indicators and Buttons.](#)



## Operating Wireless Devices

For your ease of operations, you can turn on/off your wireless devices through the proprietary software application - “**Device Power Manager**”.

**Note:**

- *Depending on the configuration of your tablet computer, your Device Power Manager menu may be displayed differently from the screenshots provided in the following section. Only wireless modules installed in your tablet computer are accessible.*
- *When you adjust User Account Control (UAC), a security feature in Windows, the setting value of Device Power Manager will be affected. So, once there is any adjustment on UAC, please uninstall Device Power Manager and reinstall it again.*

### **Bluetooth® (Option)**

An optional Bluetooth module provides your tablet computer with a short-range wireless communication protocol to connect with other compatible devices via the pre-installed embedded antenna. To activate your Bluetooth functions, please follow the instructions below.

#### **1. Driver & Application Installation**

- a. Install the Bluetooth driver first. Read from the Utility DVD and find the directory listed in the readme file to finish installation.
- b. Install the Device Power Manager application. Read from the Utility DVD and find the directory listed in the readme file to finish installation.

## 2. Launch the Device Power Manager

After launching the utility, please tap “Bluetooth” to enable the Bluetooth function (tap again to disable). Once the Bluetooth function starts up, the wireless LED indicator (color blue) will turn on and the Bluetooth icon will show up in the operating system accordingly.



Tap “Bluetooth” to enable the Bluetooth function (tap again to disable).

## Wireless LAN (Option)

Wireless LAN is an optional wireless communication module for your tablet computer. The Wireless LAN supports Wi-Fi 802.11 a/b/g/n. An embedded antenna will be pre-installed in your tablet computer to access the internet wirelessly. To activate your Wireless LAN function, please follow the illustrations below:

### 1. Driver & Application Installation

- a. Install the Chipset Driver first. Read from the Utility DVD and find the directory listed in the readme file to finish installation.
- b. Then, install the Device Power Manager application. Read from the Utility DVD and find the directory listed in the readme file to finish installation.

### 2. Launch the Device Power Manager

After launching the utility, please tap “Wireless LAN” for enabling the Wireless LAN function (tap again to disable).



Tap “Wireless LAN” to enable the Wireless LAN function (tap again to disable).

Once the Wireless LAN function starts up, the wireless device LED indicator will turn on (color blue) and the Wireless LAN icon will appear in the OS accordingly.

## Wireless Wide Area Network (Option)

Wireless Wide Area Network (WWAN) is an optional module for your tablet computer. With pre-installed embedded antenna and the optional 3.5G WWAN module, your tablet computer will be able to engage in WWAN functions.

### 1. Driver & Application Installation

- a. Please Install the WWAN driver first. For detailed instructions on installation procedures, please read from the Utility DVD and find the directory listed in the readme file. Follow the installation instructions to finish the driver installation.
- b. Install the Device Power Manager application. Read from the Utility DVD and find the directory listed in the readme file to finish installation.

### 2. Insert the SIM card

- a. Turn OFF your tablet computer.
- b. Pull down the rubber lock cover.
- c. Insert the SIM card into the SIM card slot. To avoid damaging the SIM card slot, please make sure that the golden contact area on the SIM card is facing **upward** and the beveled corner is facing towards the tablet, as shown below.



- d. Firmly push the rubber lock cover back.

#### **Note:**

- *If you encounter difficulties in ejecting your SIM card, a coin of suitable size may be used in aiding the ejection of SIM card.*

### 3. Launch the Device Power Manager

After launching the application, please tap “WWAN” for enabling the WWAN function (tap again to disable). Once the WWAN function starts up, the wireless device LED indicator will turn on (color blue).



Tap “WWAN” to enable the WWAN function (tap again to disable).

4. Enter into OS

- a. Tap “Network” icon on the taskbar.

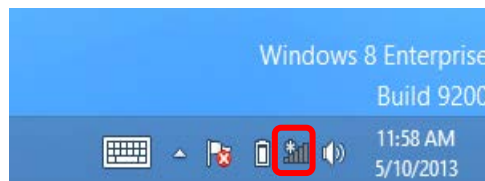

- b. Tap Mobile broadband for the telecom.

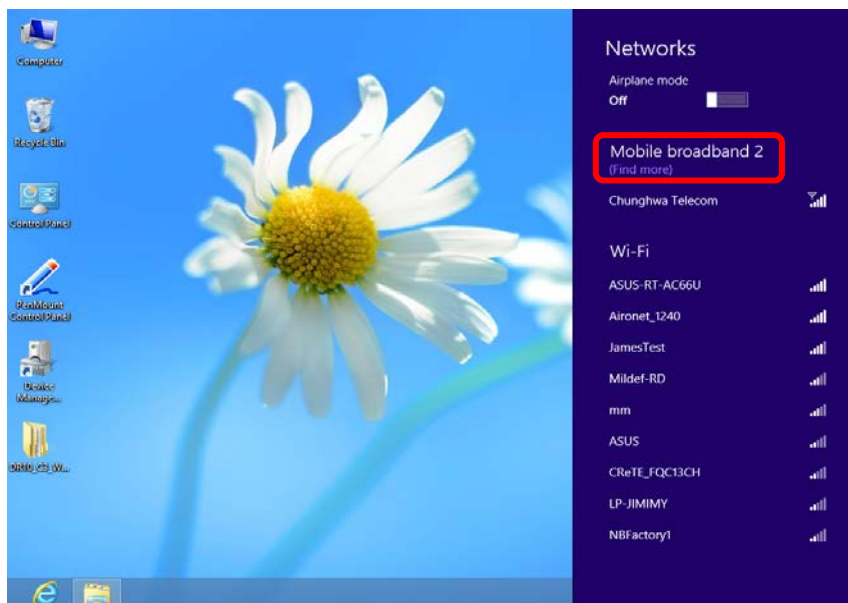

c. Tap “Connect” for connection.

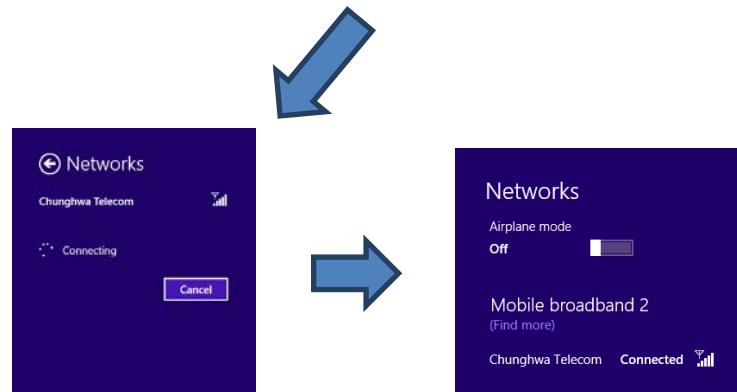
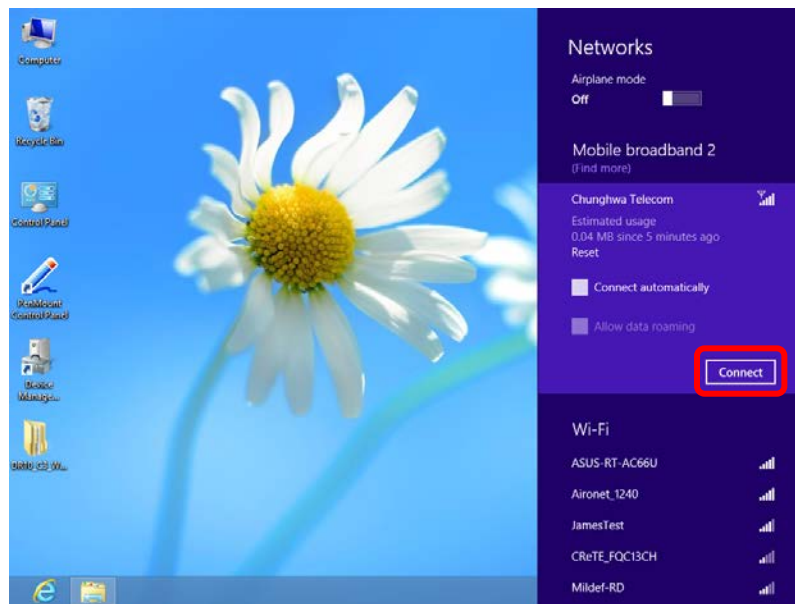

d. Tap “Disconnect” to end the connection

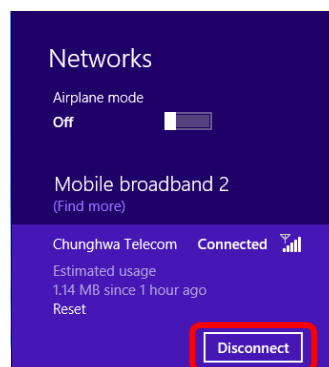

## GPS (Option)

GPS is an optional module for your tablet computer. This GPS module supports both GPS and Galileo systems. An embedded antenna is pre-installed in your tablet computer to support the functions of your GPS.

### 1. Driver & Application Installation

- a. Install the Device Power Manager application:  
Read from the Utility DVD and find the directory listed in the readme file to finish installation.
- b. Install the GPS driver:  
GPS (Driver): Read from the Utility DVD and find the directory listed in the readme file to finish installation.



Tap "GPS" to enable the GPS function (tap again to disable).

### 2. Navigation & Mapping Software Installation

Please install your 3rd party navigation and mapping software after installing your GPS driver. Refer to your navigation and mapping software manual for installation and procedures on application setup and access.

**Note:**

- Wireless devices can be turned ON/OFF through BIOS. Once a device is turned off through BIOS, its button on the Device Power Manager will be colored in yellow background and with a prohibition marker. The following illustration shows that WWAN and GPS devices are disabled through BIOS. To turn on, please enter into BIOS and enable the functions. For more information on BIOS setting, please refer to [RF Device Control Configuration Sub-Menu](#) section.





## Using Docklight DL10 (Option)

Docklight acts as docking unit or port enhancer. It contains more ports that are not available on system unit.

### Mount Docklight

1. Open the rubber cap on the docking connector.
2. Align the docking connector.
3. Attach Docklight.
4. Fix the screws.

### Docklight ports

#### Top

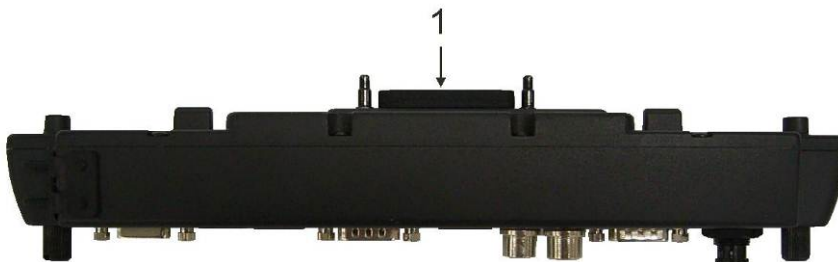

1. Docking connector

#### Bottom and Left:

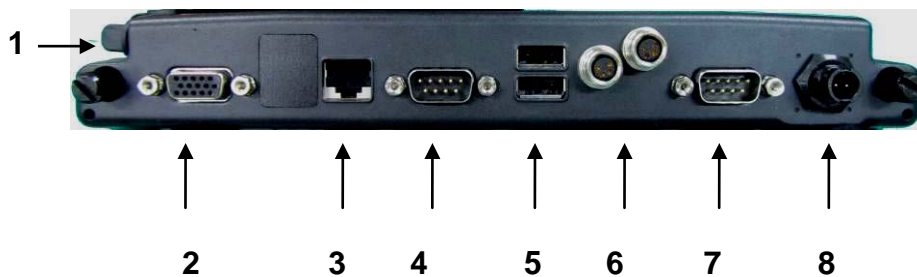

1. Audio jacks (Microphone/Speaker)
2. RGB DB15 port
3. Optional GLAN RJ45
4. Serial port (COM3: Default RS232)
5. USB port 1, 2 (standard type)
6. USB port 3, 4 (proprietary sealed type)
7. Serial port (COM2: Default RS232)
8. DC power jack
  - Default: 2-pin
  - Optional: Mil 3-pin

**Note:**

- *The combination of DK10+DL8 or DK8+DL10 is not fully compatible. A few functions, including audio, modem, and surge protector, are incompatible in these combinations.*

## Chapter3- Managing Power

### AC Adapter

The AC adapter performs two functions:

- It powers the computer from an external AC source.
- It charges the computer battery.

The adapter automatically detects the AC line voltage (110V or 220V) and adjusts accordingly.

The following are recommended when using the AC adapter:

- Use a properly grounded AC outlet.
- Use one AC outlet exclusively for the computer. Having other appliances on the same line may cause interference.
- Use a power strip with built-in surge protection.

Connect the AC adapter:

- Plug the AC cord to the adapter.
- Plug the other end of the AC cord into the wall outlet. Make sure the green LED on the adapter turns on.
- Attach the DC plug into the power jack of the computer; turn the lock ring clockwise to secure it.

### AC Adapter Indicator

The green LED indicates that AC power is ready.

---

**Battery**

The computer will automatically switch to battery when the external power source (AC adapter or optional vehicle adapter) is disconnected.

**Battery Power Saving Tips**

The computer comes with an intelligent power-saving feature. You may extend the battery life by:

- Setup power saving functions in Operating System Power Management options (e.g. Windows Power Options).
- Lower the intensity of the display by brightness control.
- Turn the computer into standby (by Sleep or Power button) when it is temporarily not in use.
- Shut down the computer when it will not be in use for longer period of time.

**Battery Low**

When the battery is nearly exhausted, the computer gives the following “Battery Low” warnings:

- Windows battery low warning.
- The power LED flashes.

Once the “Battery Low” warning occurs, please:

- Save and close the files you are currently working on then shut down the computer.
- Plug in AC or vehicle adapter to recharge the battery.

## Battery Gauge

You may check battery status from battery gauge. Click the power/battery icon to reveal the battery gauge window. The following is the illustration of Battery Gauge in Windows OS.

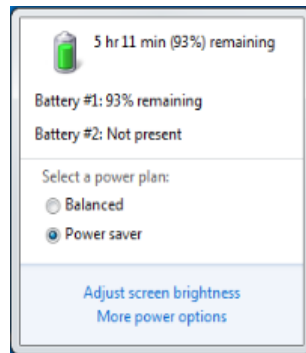

### Note:

- *Battery characteristic varies depending on factors such as ambient temperature, charging method, load current, aging, etc. For example, the chemicals of the battery are more inactive at low temperature, thus decreases the output power.*
- *The battery gauge should only be used as a reference. Please do not expect it to show the exact amount of the power remaining. There is no memory effect on Lithium Ion battery cells. However, discharge the battery to nearly empty every month will help calibrating the internal gauge.*

## Charging the Battery

Plug in the AC adapter or vehicle adapter to start the battery charging. If the battery is already full, the sense circuitry will stop high current charge within several minutes.

The LED Indicator turns ON when the battery is charging and turns OFF when the battery charge is completed.

To charge the Secondary Battery, simply install it into the computer and attach the AC adapter. The internal charger will first charge the Primary battery and then Secondary one. Optional Multi Battery Charger can charge Primary and Secondary batteries externally.

## ACPI Support

Your computer supports ACPI (Advanced Configuration and Power Interface) for power management. With ACPI and an ACPI-compliant operating system (such as Microsoft Windows), this feature will allow you to reduce the power consumption and conserve energy. By supporting ACPI, the AC adapter LED and the Power indicator LED will show in different ways. The followings are detailed descriptions of LED indicators and their meanings:

**Sleep:**

Power LED indicator is blinking RED; other LED indicators are OFF

**Hibernate:**

All LED indicators are OFF

**Shut down:**

All LED indicators are OFF

## USB Fast Charging

Your tablet supports USB fast charging feature, enabling to quickly charge your fast-charging compatible devices. But note, fast charging is not supported in every power mode. The following table shows details for USB Charging information:

Mode		USB 2.0 Charging Features
Power off	AC	Fast charging supports
	Battery	No charging
Power on	AC	Normal charging
	Battery	Normal charging
S3	AC	Fast charging supports
	Battery	Fast charging supports

# Chapter 4 - BIOS Setup

Press [F2] at boot up to enter BIOS setup. Use arrow keys to select options and [+/-] to modify them. When finished, move to “Exit” and press [Enter] then confirm save by pressing [Y].

## Main Menu

Aptio Setup Utility					
Main	Advanced	Chipset	Boot	Security	Save & Exit
<b>BIOS Information</b> BIOS Vendor Core Version Compliancy Project Version Build Date and Time EC Version				Choose the system default language	
System Language [English]				→←: Select Screen ↑↓: Select Item Enter: Select -/+ : Change Opt. F1: General Help F2: Previous Values F3: Optimized Defaults F4: Save & Exit ESC: Exit	
System Date [10/22/2012] System Time [16:19:20]					
Access Level Administrator					

**Note:**

- The contents may vary depending on computer configurations.
- Incorrect settings may cause system malfunction. To correct it, restore the Optimized Defaults with F3.

### Main Menu Selections

You can make the following selections on the Main Menu. Use the sub-menus for other selections.

Feature	Options	Description
System Date	MM/DD/YYYY	Set the system date Month, Day, Year.
System Time	HH:MM:SS	Set the system time Hour, Minute, Second.



**Advanced Menu**

Aptio Setup Utility	
Main	Advanced
<ul style="list-style-type: none"> <li>▶ Trusted Computing</li> <li>▶ SATA Configuration</li> <li>▶ Intel (R) Rapid Start Technology</li> <li>▶ USB Configuration</li> <li>▶ IT8783F Super IO Configuration</li> <li>▶ RF Device Control</li> <li>▶ EC Thermal Control</li> </ul>	<p>Trusted Computing Setting</p> <hr/> <p>→←: Select Screen            ↑↓: Select Item            Enter: Select            -/+: Change Opt.            F1: General Help            F2: Previous Values            F3: Optimized Defaults            F4: Save &amp; Exit            ESC: Exit</p>

### Advanced Menu Selections

You can make the following selections on the Advanced Menu.

Feature	Options	Description
Trusted Computing	Disabled Enabled	TPM Support
SATA Configuration	SATA Mode Selection Serial ATA Port 0 Software Preserve	SATA Mode Selection: IDE, AHCI, RAID Serial ATA Port 0 Software Preserve: Port 0, Hot Plug
Intel (R) Rapid Start Technology	Disabled Enabled	Allows the system to skip certain tests while booting. This will decrease the time needed to boot the system.
USB Configuration	Disabled Enabled	Legacy USB Support USB3.0 Support XHCI Hand-off EHCI Hand-off
IT8783F Super IO Configuration	VBIOS Default CRT LFP CRT+LFP TV LFP-SDVO EFP TV-SDVO CRT+LFP-SDVO CRT+EFP	Select the Video Device that will be activated during POST
RF Device Control	Disabled Enabled	GSM, GPS, BLUETOOTH, WLAN
EC Thermal Control		Thermal cooling trip point

### SATA Configuration Sub-Menu

Advanced		Aptio Setup Utility
SATA Mode Selection	[AHCI]	Determine how SATA controller(s) operate.
Serial ATA Port 0 Software Preserve	INTEL SSDSC2CW (180.0 SUPPORTED)	
Port 0	[Enabled]	
Hot Plug	[Disabled]	
		→←: Select Screen ↑↓: Select Item Enter: Select -/+ : Change Opt. F1: General Help F2: Previous Values F3: Optimized Defaults F4: Save & Exit ESC: Exit

### SATA Configuration Sub-Menu Selections

You can make the following selections on the SATA configuration sub-menu.

Feature	Options	Description
SATA Mode Selection	IDE AHCI RAID	
Port 0	Disabled Enabled	Enable or Disable SATA Port
Hot Plug	Disabled Enabled	Designates this port as Hot Pluggable

## USB Configuration Sub-Menu

Advanced		Aptio Setup Utility
<b>USB Configuration</b>  <b>USB Devices:</b> <b>1 point</b>  Legacy USB Support [Enabled] USB3.0 Support [Enabled] XHCI Hand-off [Enabled] EHCI Hand-off [Enabled]		Enables Legacy USB support. AUTO option disables legacy support if no USB devices are connected. Disable option will keep USB devices available only for EFI applications  →←: Select Screen ↑↓: Select Item Enter: Select -/+ : Change Opt. F1: General Help F2: Previous Values F3: Optimized Defaults F4: Save & Exit ESC: Exit

## USB Configuration Sub-Menu Selections

You can make the following selections on the USB configuration sub-menu.

Feature	Options	Description
Legacy USB enabled	Disabled Enabled	Enables Legacy USB support. AUTO option disables legacy support if no USB devices are connected. DISABLE option will keep USB devices available only for EFI applications.
Usn3.0 Support	Disabled Enabled	Enable/Disable USB3.0 (XHCI) Controller support.
XHCI Hand-off	Disabled Enabled	This is a workaround for OSeS without XHCI hand-off support. This XHCI ownership change should be claimed by XHCI driver.
EHCI Hand-off	Disabled Enabled	This is a workaround for OSeS without EHCI hand-off support. This EHCI ownership change should be claimed by EHCI driver.

### IT8783F Super IO Configuration Sub-Menu

Advanced		Aptio Setup Utility
<b>IT8783F Super IO configuration</b>  <b>IT8783F Super IO Chip</b> <b>IT8783F</b> ▶ Serial Port 0 Configuration		Set Parameters of Serial Port 0 (COMA)
		→←: Select Screen ↑↓: Select Item Enter: Select -/+ : Change Opt. F1: General Help F2: Previous Values F3: Optimized Defaults F4: Save & Exit ESC: Exit

### IT8783F Super IO Configuration Sub-Menu Selections

You can make the following selections on the IT8783F super IO configuration sub-menu.

Feature	Options	Description
Serial Port	Disabled Enabled	Enable or Disable Serial Port (COM)
Change Settings	Auto IO=3F8h; IRQ=4; IO=3F8h; IRQ=3,45,6,7,10,11,12; IO=2F8h; IRQ=3,45,6,7,10,11,12; IO=3E8h; IRQ=3,45,6,7,10,11,12; IO=2E8h; IRQ=3,45,6,7,10,11,12;	Select an optimal setting for Super IO device.
COM 1 Mode Setting	RS232 RS422 TTL 1 RS485	Com 1 Mode Setting

## RF Device Control Configuration Sub-Menu

Advanced		Aptio Setup Utility
<b>RF Device Control</b>		RF Device Control Setting
<b>GSM STATUS</b> GSM	<b>Present</b> [Enabled]	→←: Select Screen ↑↓: Select Item Enter: Select -/+ : Change Opt. F1: General Help F2: Previous Values F3: Optimized Defaults F4: Save & Exit ESC: Exit
<b>GPS STATUS</b> GPS	<b>Present</b> [Enabled]	
<b>BT STATUS</b> BLUETOOTH	<b>Present</b> [Enabled]	
<b>WLAN STATUS</b> WLAN	<b>Present</b> [Enabled]	

### RF Device Control Configuration Sub-Menu Selections

You can make the following selections on the RF Security Control sub-menu.

Feature	Options	Description
Wireless LAN	Disabled Enabled	Wireless Lan Control Enabled Wireless function
WWAN	Disabled Enabled	WWAN Control Enabled WWAN function
GPS	Disabled Enabled	GPS Control Enabled GPS function
BlueTooth	Disabled Enabled	BlueTooth Control Enabled Blue Tooth function

EC Thermal Control Sub-Menu

Advanced		Aptio Setup Utility	
<b>EC Thermal Control</b>		EC Thermal Control Setting	
Thermal cooling trip point	[87 C]		
		→←: Select Screen ↑↓: Select Item Enter: Select -/+ : Change Opt. F1: General Help F2: Previous Values F3: Optimized Defaults F4: Save & Exit ESC: Exit	

## Chipset Menu

Aptio Setup Utility		
Main	Advanced	Chipset
▶ System Agent (SA) Configuration		System Agent (SA) Parameters
▶ PCH-IO Configuration		
		→←: Select Screen ↑↓: Select Item Enter: Select -/+: Change Opt. F1: General Help F2: Previous Values F3: Optimized Defaults F4: Save & Exit ESC: Exit

### Chipset Menu Selections

You can make the following selections on the Chipset sub-menu.

Feature	Options	Description
System Agent (SA) Configuration		System Agent (SA) Parameters
PCH-IO Configuration		PCH Parameter

### PCH-IO Configuration Sub-Menu

Aptio Setup Utility		
Chipset		
Intel PCH RC Version	1.2.2.0	Enable or disable onboard NIC.
Intel PCH SKU Name	QM67	
Intel PCH Rev ID	05/B3	
PCH LAN Controller	[Enabled]	→←: Select Screen ↑↓: Select Item Enter: Select -/+: Change Opt. F1: General Help F2: Previous Values F3: Optimized Defaults F4: Save & Exit ESC: Exit
Wake on LAN	[Enabled]	
▶ USB Configuration		
▶ PCI Express Configuration		



**PCH-IO Configuration Sub-Menu Selections**

You can make the following selections on the PCH-IO Configuration sub-menu.

<b>Feature</b>	<b>Options</b>	<b>Description</b>
PCH LAN Controller	Disabled Enabled	Enable or disable onboard NIC.
Wake on LAN	Disabled Enabled	Enable or disable integrated LAN to wake the system
USB Configuration	Disabled Enabled	USB Configuration settings
PCI Express Configuration	Disabled Enabled	PCI Express Configuration settings

## Boot Menu

Aptio Setup Utility					
Main	Advanced	Chipset	Boot	Security	Save & Exit
<b>Boot Option Priorities</b> Boot Option #1 [PO: INTEL SSDSC2CW...] Boot Option #2 [IBA GE Slot 00C8 v...]  Network Device BBS Priorities Hard Driver BBS Priorities				Sets the system boot order	
				→←: Select Screen ↑↓: Select Item Enter: Select -/+ : Change Opt. F1: General Help F2: Previous Values F3: Optimized Defaults F4: Save & Exit ESC: Exit	

The system will try to boot from device on top then the 2<sup>nd</sup> and so on. If there is more than one device in each category, only the device on top of sub-menu can boot up.

### Boot Menu Selections

You can make the following selections on the Boot menu.

Feature	Options	Description
Boot Option #1		Sets the system boot order
Boot Option #2		Sets the system boot order
Network Device BBS Priorities		Set the order of the legacy devices in this group
Hard Drive BBS Priorities		Set the order of the legacy devices in this group

## Security Menu

Aptio Setup Utility	
Main	Advanced
Chipset	Boot
Security	Save & Exit
<p><b>Password Description</b></p> <p>If <b>ONLY</b> the Administrator's password is set, then this only limits access to Setup and is only asked for when entering Setup.</p> <p>If <b>ONLY</b> the User's password is set, then this is a power on password and must be entered to boot or enter Setup. In Setup the User will have Administrator rights.</p> <p>The password length must be in the following range;</p> <p><b>Minimum length</b>           3</p> <p><b>Maximum length</b>         20</p> <p>Administrator Password</p> <p>User Password</p> <p><b>HDD Security Configuration:</b></p> <p>HDD 0: INTEL SSDSC2</p>	<p>Set Administrator Password</p> <p>→←: Select Screen</p> <p>↑↓: Select Item</p> <p>Enter: Select</p> <p>-/+ : Change Opt.</p> <p>F1: General Help</p> <p>F2: Previous Values</p> <p>F3: Optimized Defaults</p> <p>F4: Save &amp; Exit</p> <p>ESC: Exit</p>

### Security Menu Selections

You can make the following selections on the Security Menu.

Feature	Options	Description
Administrator Password	Enter New Password Confirm New Password	Controls detection of Processor Serial No. System must be reset or restarted from power-on for settings to take effect.
User password	Enter New Password Confirm New Password	Supervisor Password controls access to the setup utility.
HDD 0: INTEL SSDSC2	Enter New Password Confirm New Password	User Password controls access to the system at boot.

## Save & Exit Menu

Aptio Setup Utility					
Main	Advanced	Chipset	Boot	Security	Save & Exit
Save Changes and Exit Discard Changes and Exit Save Changes and Reset Discard Changes and Reset				Exit system setup after saving the changes	
<b>Save Options</b> Save Changes Discard Changes  Restore Defaults Save as User Defaults Restore User Defaults				→←: Select Screen ↑↓: Select Item Enter: Select -/+ : Change Opt. F1: General Help F2: Previous Values F3: Optimized Defaults F4: Save & Exit ESC: Exit	
<b>Boot Override</b> PO: INTEL SSDSC2CW180A3 IBA GE Slot 00C8 v1365 Realtek PXE B01 D00					

## Chapter 5 – Drivers and Applications

The Utility DVD includes all the drivers for the installed devices in your tablet computer. Please consult the dealer if there is any driver missing. Also, through Device Manager in Windows, you are able to perform “Driver Update” or check if there are still drivers for the devices needed to be installed. Please check the readme file on Utility DVD to get the latest information before installing device drivers.

**Note:**

- *Please install the chipset driver first.*
- *If the system requests for reboot after installing drivers, please reboot your tablet computer first before installing other drivers.*

### Chipset

**Windows® 7/Ultimate 64-bit:**

Run "Setup.exe" in the directory of "\\Drivers\Windows 7 (64-bit)\Intel\_Chipset", and then follow the instructions to install.

**Windows® 7/Ultimate 32-bit:**

Run "Setup.exe" in the directory of "\\Drivers\Windows 7 (32-bit)\Intel\_Chipset", and then follow the instructions to install.

**Windows® 8/Ultimate 64-bit:**

Run "infinst\_autol.exe" in the directory of "\\Drivers\Windows 8 (64-bit)\Intel\_Chipset", and then follow the instructions to install.

**Windows® 8/Ultimate 32-bit:**

Run "infinst\_autol.exe" in the directory of "\\Drivers\Windows 8 (32-bit)\Intel\_Chipset", and then follow the instructions to install.

## VGA

**Windows® 7/Ultimate 64-bit:**

Run "win64\_15288.exe" in the directory of "\\Drivers\Windows 7 (64-bit)\Intel\_VGA", and then follow the instructions to install.

**Windows® 7/Ultimate 32-bit:**

Run "win64\_15288.exe" in the directory of "\\Drivers\Windows 7 (32-bit)\Intel\_VGA", and then follow the instructions to install.

**Windows® 8/Ultimate 64-bit:**

Run "win64\_152812.exe" in the directory of "\\Drivers\Windows 8 (64-bit)\Intel\_VGA\64bit", and then follow the instructions to install.

**Windows® 8/Ultimate 32-bit:**

Run "win32\_152812.exe" in the directory of "\\Drivers\Windows 8 (32-bit)\Intel\_VGA", and then follow the instructions to install.

## Audio

**Windows® 7/Ultimate 64-bit:**

Run "Setup.exe" in the directory of "\\Drivers\Windows 7 (64-bit)\Audio\6777\_PG360\_Win8\_Win7\_Vista\_XP", and then follow the instructions to install.

**Windows® 7/Ultimate 32-bit:**

Run "Setup.exe" in the directory of "\\Drivers\Windows 7 (32-bit)\Audio\6777\_PG360\_Win8\_Win7\_Vista\_XP", and then follow the instructions to install.

**Windows® 8/Ultimate 64-bit:**

Run "Setup.exe" in the directory of "\\Drivers\Windows 8 (64-bit)\Audio\6777\_PG360\_Win8\_Win7\_Vista\_XP", and then follow the instructions to install.

**Windows® 8/Ultimate 32-bit:**

Run "Setup.exe" in the directory of "\\Drivers\Windows 8 (32-bit)\Audio\6777\_PG360\_Win8\_Win7\_Vista\_XP", and then follow the instructions to install.

## Intel ME

### Windows® 7/Ultimate 64-bit:

Run "Setup.exe" in the directory of "\\Drivers\Windows 7 (64-bit)\Intel\_ME\MEI\_allOS\_7.1.40.1161\_PV", and then follow the instructions to install.

### Windows® 7/Ultimate 32-bit:

Run "Setup.exe" in the directory of "\\Drivers\Windows 7 (32-bit)\Intel\_ME\MEI\_allOS\_7.1.40.1161\_PV", and then follow the instructions to install.

### Windows® 8/Ultimate 64-bit:

Run "Setup.exe" in the directory of "\\Drivers\Windows 8 (64-bit)\Intel\_ME\MEI\_allOS\_7.1.40.1161\_PV", and then follow the instructions to install.

### Windows® 8/Ultimate 32-bit:

Run "Setup.exe" in the directory of "\\Drivers\Windows 8 (32-bit)\Intel\_ME\MEI\_allOS\_7.1.40.1161\_PV", and then follow the instructions to install.

## Intel Rapid Storage Technology

### Windows® 7/Ultimate 64-bit:

Run "iata\_cd\_10.8.0.1003.exe" in the directory of "Drivers\Windows 7 (64-bit)\IntelR Rapid Storage Technology", and then follow the instructions to install.

### Windows® 7/Ultimate 32-bit:

Run "iata\_cd\_10.8.0.1003.exe" in the directory of "Drivers\Windows 7 (32-bit)\IntelR Rapid Storage Technology", and then follow the instructions to install.

### Windows® 8/Ultimate 64-bit:

Run "iata\_cd.exe" in the directory of "Drivers\Windows 8 (64-bit)\IntelR Rapid Storage Technology", and then follow the instructions to install.

### Windows® 8/Ultimate 32-bit:

Run "iata\_cd.exe" in the directory of "Drivers\Windows 8 (32-bit)\IntelR Rapid Storage Technology", and then follow the instructions to install.

## Wireless Power Manager

**Windows® 7/Ultimate 64-bit:**

Run "setup.exe" in the directory of "\\Utilities\0107\", and then follow the instructions to install.

**Windows® 7/Ultimate 32-bit:**

Run "setup.exe" in the directory of "\\Utilities\0107\", and then follow the instructions to install.

**Windows® 8/Ultimate 64-bit:**

Run "setup.exe" in the directory of "\\Utilities\0620\", and then follow the instructions to install.

**Windows® 8/Ultimate 32-bit:**

Run "setup.exe" in the directory of "\\Utilities\0620\", and then follow the instructions to install.

## Touch Screen

**Windows® 7/Ultimate 64-bit:**

Run "setup.exe" in the directory of "\\Drivers\Windows 7 (64-bit)\Touch Screen\PenMount Windows Universal Driver V2.4.0.306(WHQL)", and then follow the instructions to install.

**Windows® 7/Ultimate 32-bit:**

Run "setup.exe" in the directory of "\\Drivers\Windows 7 (32-bit)\Touch Screen\PenMount Windows Universal Driver V2.4.0.306(WHQL)", and then follow the instructions to install.

**Windows® 8/Ultimate 64-bit:**

Run "setup.exe" in the directory of "\\Drivers\Windows 8 (64-bit)\Touch Screen\PenMount Windows Universal Driver V2.4.0.306(WHQL)", and then follow the instructions to install.

**Windows® 8/Ultimate 32-bit:**

Run "setup.exe" in the directory of "\\Drivers\Windows 8 (32-bit)\Touch Screen\PenMount Windows Universal Driver V2.4.0.306(WHQL)", and then follow the instructions to install.



## USB3.0

### Windows® 7/Ultimate 64-bit:

Run "Texas Instruments xHCI Driver v1.12.25 ( Multilenguaje - WHQL ).exe" in the directory of "\\Drivers\Windows 7 (64-bit)\USB3.0\Texas Instruments xHCI Driver v1.12.25 ( Multilenguaje - WHQL )", and then follow the instructions to install.

### Windows® 7/Ultimate 32-bit:

Run "Texas Instruments xHCI Driver v1.12.25 ( Multilenguaje - WHQL ).exe" in the directory of "\\Drivers\Windows 7 (32-bit)\USB3.0\Texas Instruments xHCI Driver v1.12.25 ( Multilenguaje - WHQL )", and then follow the instructions to install.

### Windows® 8/Ultimate 64-bit:

Run "Texas\_Instruments\_xHCI\_Driver\_v1.16.2.0\_WHQL\_(Multilanguage).exe" in the directory of "\\Drivers\Windows 7 (64-bit)\USB3.0\Texas\_Instruments\_xHCI\_Driver\_v1.16.2.0\_WHQL\_(Multilanguage)", and then follow the instructions to install.

### Windows® 8/Ultimate 32-bit:

Run "Texas\_Instruments\_xHCI\_Driver\_v1.16.2.0\_WHQL\_(Multilanguage).exe" in the directory of "\\Drivers\Windows 8 (32-bit)\USB3.0\Texas\_Instruments\_xHCI\_Driver\_v1.16.2.0\_WHQL\_(Multilanguage)", and then follow the instructions to install.

## Ricoh SD Controller

### Windows® 7/Ultimate 64-bit:

Run "setup.exe" in the directory of "\\Drivers\Windows 7 (64-bit)\Ricoh\Ricoh\_Media\_Driver\_v2.13.16.01", and then follow the instructions to install.

### Windows® 7/Ultimate 32-bit:

Run "setup.exe" in the directory of "\\Drivers\Windows 7 (32-bit)\Ricoh\Ricoh\_Media\_Driver\_v2.13.16.01", and then follow the instructions to install.

### Windows® 8/Ultimate 64-bit:

Run "setup.exe" in the directory of "\\Drivers\Windows 8 (64-bit)\Ricoh\Ricoh\_Media\_Driver\_v2.24.12.11", and then follow the instructions to install.

### Windows® 8/Ultimate 32-bit:

Run "setup.exe" in the directory of "\\Drivers\Windows 8 (32-bit)\Ricoh\Ricoh\_Media\_Driver\_v2.24.12.11", and then follow the instructions to install.

## Turbo Boost Monitor

**Windows® 7/Ultimate 64-bit:**

Run "setup.exe" in the directory of "\\Drivers\Windows 7 (64-bit)\IntelR Turbo Boost Technology Monitor", and then follow the instructions to install.

**Windows® 7/Ultimate 32-bit:**

Run "setup.exe" in the directory of "\\Drivers\Windows 7 (32-bit)\IntelR Turbo Boost Technology Monitor", and then follow the instructions to install.

**Windows® 8/Ultimate 64-bit:**

Run "setup.exe" in the directory of "\\Drivers\Windows 8 (64-bit)\IntelR Turbo Boost Technology Monitor", and then follow the instructions to install.

**Windows® 8/Ultimate 32-bit:**

Run "setup.exe" in the directory of "\\Drivers\Windows 8 (32-bit)\IntelR Turbo Boost Technology Monitor", and then follow the instructions to install.

## Gigabit LAN

**Windows® 7/Ultimate 64-bit:**

Run "PROWinx64.exe" in the directory of "\\Drivers\Windows 7 (64-bit)\Intel\_82579LM", and then follow the instructions to install.

**Windows® 7/Ultimate 32-bit:**

Run "PROWinx32.exe" in the directory of "\\Drivers\Windows 7 (32-bit)\Intel\_82579LM", and then follow the instructions to install.

**Windows® 8/Ultimate 64-bit:**

Run "PROWinx64.exe" in the directory of "\\Drivers\Windows 8 (64-bit)\Intel\_82579", and then follow the instructions to install.

**Windows® 8/Ultimate 32-bit:**

Run "PROWinx32.exe" in the directory of "\\Drivers\Windows 8 (32-bit)\Intel\_82579", and then follow the instructions to install.

## 2nd Gigabit LAN (Option)

### Windows®7/Ultimate 64-bit:

Run "setup.exe" in the directory of "\\Drivers\Windows 7 (64-bit)\RTL8111E\Install\_Win7\_7046\_07202011", and then follow the instructions to install.

### Windows® 7/Ultimate 32-bit:

Run "setup.exe" in the directory of "\\Drivers\Windows 7 (32-bit)\RTL8111E\Install\_Win7\_7046\_07202011", and then follow the instructions to install.

### Windows® 8/Ultimate 64-bit:

Run "setup.exe" in the directory of "\\Drivers\Windows 8 (64-bit)\RTL8111E\Install\_Win7\_7046\_07202011", and then follow the instructions to install.

### Windows® 8/Ultimate 32-bit:

Run "setup.exe" in the directory of "\\Drivers\Windows 8 (32-bit)\RTL8111E\Install\_Win7\_7046\_07202011", and then follow the instructions to install.

## WiFi (Option)

### Windows® 7/Ultimate 64-bit:

Run "Wireless\_15.3.1\_Ds64.exe" in the directory of "\\Drivers\Windows 7 (64-bit)\Intel\_WiFi6235\WLAN\64bit", and then follow the instructions to install.

\*: Then into the "Wireless Power Manager" to turn on the WLAN device.

### Windows® 7/Ultimate 32-bit:

Run "Wireless\_15.3.1\_Ds32.exe" in the directory of "\\Drivers\Windows 7 (32-bit)\Intel\_WiFi6235\WLAN\32bit", and then follow the instructions to install.

\*: Then into the "Wireless Power Manager" to turn on the WLAN device.

### Windows® 8/Ultimate 64-bit:

Run "Wireless\_15.6\_De64.exe" in the directory of "\\Drivers\Windows 8 (64-bit)\Intel\_WiFi6235\WLAN\64bit", and then follow the instructions to install.

\*: Then into the "Wireless Power Manager" to turn on the WLAN device.

### Windows® 8/Ultimate 32-bit:

Run "Wireless\_15.6\_De32.exe" in the directory of "\\Drivers\Windows 8 (32-bit)\Intel\_WiFi6235\WLAN\32bit", and then follow the instructions to install.

\*: Then into the "Wireless Power Manager" to turn on the WLAN device.

## Bluetooth (Option)

### Windows® 7/Ultimate 64-bit:

\*: First into the "Wireless Power Manager" to turn on the Bluetooth device.

Run "BT\_2.2\_s64.exe" in the directory of "\\Drivers\Windows 7 (64-bit)\Intel\_WiFi6235\BT\64bit", and then follow the instructions to install.

### Windows® 7/Ultimate 32-bit:

\*: First into the "Wireless Power Manager" to turn on the Bluetooth device.

Run "BT\_2.2\_s32.exe" in the directory of "\\Drivers\Windows 7 (32-bit)\Intel\_WiFi6235\BT\32bit", and then follow the instructions to install.

### Windows® 8/Ultimate 64-bit:

\*: First into the "Wireless Power Manager" to turn on the Bluetooth device.

Run "BT\_2.6.1211\_e64.exe" in the directory of "\\Drivers\Windows 8 (64-bit)\Intel\_WiFi6235\BT\64bit", and then follow the instructions to install.

### Windows® 8/Ultimate 32-bit:

\*: First into the "Wireless Power Manager" to turn on the Bluetooth device.

Run "BT\_2.6.1211\_e32.exe" in the directory of "\\Drivers\Windows 7 (32-bit)\Intel\_WiFi6235\BT\32bit", and then follow the instructions to install.

## GPS (Option)

### Windows® 7/Ultimate 64-bit:

\*: First into the "Wireless Power Manager" to turn on the GPS device.

Run "ublox\_A4\_U5\_USB\_drv3264\_install\_UI.exe" in the directory of "\\Drivers\Windows 7 (64-bit)\UBlox 6H Driver", and then follow the instructions to install.

### Windows® 7/Ultimate 32-bit:

\*: First into the "Wireless Power Manager" to turn on the GPS device.

Run "ublox\_A4\_U5\_USB\_drv3264\_install\_UI.exe" in the directory of "\\Drivers\Windows 7 (32-bit)\UBlox 6H Driver", and then follow the instructions to install.

### Windows® 8/Ultimate 64-bit:

\*: First into the "Wireless Power Manager" to turn on the GPS device.

Run "ublox\_A4\_U5\_USB\_drv3264\_install\_UI.exe" in the directory of "\\Drivers\Windows 8 (64-bit)\UBlox 6H Driver", and then follow the instructions to install.

### Windows® 8/Ultimate 32-bit:

\*: First into the "Wireless Power Manager" to turn on the GPS device.

Run "ublox\_A4\_U5\_USB\_drv3264\_install\_UI.exe" in the directory of "\\Drivers\Windows 8 (32-bit)\UBlox 6H Driver", and then follow the instructions to install.

## WWAN (Option)

### Windows® 7/Ultimate 64-bit:

\*: First into the "Wireless Power Manager" to turn on the WWAN device.

Install Driver:

Run "SWIGobi3kSetup.exe" in the directory of "\\Drivers\Windows 7 (64-bit)\AirPrime MC8305 HSPA module (Gobi)\GenericGobi3k", and then follow the instructions to install.

Install MC8305 module AP:

Run "Watcher\_Generic\_Q.msi" in the directory of "\\Drivers\Windows 7 (64-bit)\AirPrime MC8305 HSPA module (Gobi)", and then follow the instructions to install.

### Windows® 7/Ultimate 32-bit:

\*: First into the "Wireless Power Manager" to turn on the WWAN device.

Inteall Driver:

Run "SWIGobi3kSetup.exe" in the directory of "\\Drivers\Windows 7 (32-bit)\AirPrime MC8305 HSPA module (Gobi)\GenericGobi3k", and then follow the instructions to install.

Install MC8305 module AP:

Run "Watcher\_Generic\_Q.msi" in the directory of "\\Drivers\Windows 7 (32-bit)\AirPrime MC8305 HSPA module (Gobi)", and then follow the instructions to install.

### Windows® 8/Ultimate 64-bit:

\*: First into the "Wireless Power Manager" to turn on the WWAN device.

Install Driver:

Run "SWIQMIGobi3kSetup.exe" in the directory of "\\Drivers\Windows 8 (64-bit)\AirPrime MC8305 HSPA module (Gobi)\GenericGobi3k", and then follow the instructions to install.

### Windows® 8/Ultimate 32-bit:

\*: First into the "Wireless Power Manager" to turn on the WWAN device.

Inteall Driver:

Run "SWIQMIGobi3kSetup.exe" in the directory of "\\Drivers\Windows 7 (32-bit)\AirPrime MC8305 HSPA module (Gobi)\GenericGobi3k", and then follow the instructions to install.

## TPM (Option)

### **Windows® 7/Ultimate 64-bit:**

\*: First into the "BIOS" to turn on the TPM device.

Run "setup.exe" in the directory of "\\Drivers\Windows 7 (64-bit)\TPM", and then follow the instructions to install.

### **Windows® 7/Ultimate 32-bit:**

\*: First into the "BIOS" to turn on the TPM device.

Run "setup.exe" in the directory of "\\Drivers\Windows 7 (32-bit)\TPM", and then follow the instructions to install.

### **Windows® 8/Ultimate 64-bit:**

\*: First into the "BIOS" to turn on the TPM device.

Run "setup.exe" in the directory of "\\Drivers\Windows 8 (64-bit)\TPM", and then follow the instructions to install.

### **Windows® 8/Ultimate 32-bit:**

\*: First into the "BIOS" to turn on the TPM device.

Run "setup.exe" in the directory of "\\Drivers\Windows 8 (32-bit)\TPM", and then follow the instructions to install.

## Chapter 6 – Specifications

### Platform

Intel® Huron River Platform

### CPU

Intel® Sandy Bridge i7-2610UE  
- 4 MB Intel Smart Cache Memory

### PCH

Intel® Cougar Point QM67

### Memory

Max. 8GB System Memory  
- Industrial grade  
- DDR3 SO-DIMM x 1, 1333MHz

### Touch Screen

Type: 12.1" XGA LCD with LED B/L  
Resolution: 1024 x 768 pixels  
Brightness (min.~ typ.): 280 nits ~ 350 nits  
Single touch resistive  
Sunlight readable

### Hard Disk Drive (HDD)/Solid State Drive (SSD)

Type: 2.5"  
Interface: SATA II

### Buttons

Buttons are with Backlight  
Function keys: F1~F4  
Please also refer to [Appearance Overview](#) section for more information.

### Audio

HD Audio and Stereo Speakers



## I/O Ports

- Serial port DB9 (Default RS232)
- GLAN RJ45
- Multi Bay:
  - ExpressCard slot (ExpressCard/54) x 1(Top)
  - SIM Card slot x 1 + SD Card slot x 1(Bottom)
- Docking connector x 1
- USB 3.0 port x 1
- USB 2.0 with Fast Charger port x1
- DC power jack

**Note:**

- *WOR (Wake On Ring) is provided only on COM1.*

## Dimensions and Weight

Width:	12.1 in (310mm)
Depth:	10 in (255mm)
Height:	2.1 in (54mm)
Weight:	5.5 lb (2.5Kg)

**Note:**

- *Weight varies depending on system configurations.*

## Power

### Primary Battery:

Type:	9 x 18650 cells Lithium Ion
Capacity:	11.1V/ 7200mAh
Dimension:	6.42 in (W) x 3.04 in (D) x 0.81 in (H) / 163 mm (W) x 77 mm (D) x 20.5mm (H)
Weight:	0.98 lb (445 g)

### Optional 2<sup>nd</sup> Battery:

Type:	9 x 18650 cells Lithium Ion
Capacity:	11.1V/ 7200mAh
Dimension:	5.91 in (W) x 3.54 in (D) x 0.79 in (H) / 150 mm (W) x 90 mm (D) x 20 mm (H)
Weight:	1.1 lb (500 g)

### AC Adapter

Input Voltage:	AC 100 - 240V
Frequency:	50/60 Hz
Output Voltage:	DC 19V
Maximum Power:	90 Watts
Dimension:	5.24 in (W) x 2.28 in (D) x 1.18 in (H) / 133 mm (W) x 58mm (D) x 30mm (H)
Weight:	0.88 lb (400 g)

### DC-In:

- 12~32V with Surge Protector
- I-model: Industry 2 pin DC-in Connector
  - M-model: Military 3 pin DC-in Connector

## Environmental, Safety & EMC

CE, FCC, WEEE, REACH, IP65, MIL-STD-810G, MIL-STD-461F (for M model)

---

## **Materials and Recycling**

Materials of the computer are as follows:

Cabinet:	Magnesium alloy AZ91D UL grade PC+ABS GE C2800 or TN-3813BW
Bracket:	Aluminum 5052 Steel with Nickel plating Stainless Steel S304
PCB:	FR-4, UL 94V0
Battery:	Rechargeable Lithium Ion cells
Packing:	Carton: Unbleached paper Cushion: Recyclable PE Carrying bag: Recyclable PE Fiber Quick Guide: Paper

Please recycle the parts according to local regulations.

---

## Chapter 7 – Optional Devices

### Communication

- WiFi/Bluetooth®:
  - Intel® Centrino® Advanced-N 6235, Dual Band
  - Board Form Factor: PCIe Half Mini Card
  - Wi-Fi Certified: 802.11 a/b/g/n
  - Bluetooth: Supports BT 2.1, 2.1+EDR, 3.0, 3.0+HS, 4.0 (BLE)
  - Interface: PCIe (WiFi)/USB (BT)
- WWAN: Gobi 3000 (USB interface, Mini PCIe form factor)
- GPS: u-blox LEA-6H (USB interface)
- 2<sup>nd</sup> Gigabit LAN: 1Gbps (internal Mini PCIe Card)

### Memory Card

The memory card will expand main memory to facilitate better system performance. The cards are available as following: 4/8GB DDR3 DRAM 1333MHz (Max. Total memory 8 GB).

### 2nd Battery

A Lithium Ion rechargeable 2nd battery may mount on the rear. The computer's internal charger can detect 2nd battery and perform charging accordingly.

### Security

TPM (Trusted Platform Module) version 1.2 (on board)

## Docklight DL10

The Docklight can attach to computer or stand unit for mobile or stationary operation.

Ports: Serial x 2, USB2.0 x 4, RGB, Audio (speaker out, microphone in), DC jack, Optional Giga LAN RJ45 x 1

Dimensions: 9.84 in (W) x 1.46 in (D) x 2.40 in (H) /  
250mm (W) x 37mm (D) x 61mm (H)

Weight: 1 lb (0.45Kg) approximately

DC input: 12~32V

Environmental & Certifications: CE, FCC, IP54

### Note:

- *Serial ports: COM2/COM3 default RS232*
- *USB Ports: 2 standard and 2 proprietary environmentally sealed USB jacks.*
- *Audio port: 3.5 mm Jack*
- *Optional Giga LAN requires 2<sup>nd</sup> Giga LAN card.*

## Multi-Battery Charger

The charger provides two slots for the Primary and Secondary battery respectively. It allows charging of both batteries simultaneously and accepts power from AC adapter or Vehicle adapter. It takes approximately 3~4 hours to fully charge both batteries.



## External USB Keyboard

An optional 89-key external USB keyboard with LED backlight and IP rating of IP54 is available for your tablet computer. The detailed specification is provided below:

- 89-key layout emulates 101/102-key KB
- Life: >1 million times, water/dust protection up to IP54
- Back-light illumination (backlight device: green LED)
- PS/2 compatible Trackpoint and mouse buttons
- Dimensions: 12.73 in (W) x 6.77 in (D) x 0.98 in (H) /  
323.4 mm (W) x 172 mm (D) x 25 mm (H)
- Weight: 2.42 lb (1.1 kg)



### Track point

The track point is functionally equivalent to a mouse. Pushing the track point may move the cursor on the screen. The 2 buttons act same as mouse buttons.

### Backlight

Press **[I-O]** key for approximately 1 second turns keyboard backlight ON or OFF.

## Mini Keyboard KBD

Mini Keyboard KBD is designed for all models. KBD also brings convenience of use through multi-language keyboard versions and USB interface. The detailed specification is provided below:

- USB interface with 30 cm USB cable
- 66-Key design with function keys to simulate standard keyboards.
- StickPointer to simulate mouse and keypad
- Currently support versions:  
English (UI), English (UK), German (DE), Swedish (SV) and Russian (RU) 5 versions.
- LED Backlight
- Caps Lock, Number Lock, Scroll Lock, and Smart Card Reader LED Indicators
- Magnesium Alloy Case (Black)
- Operating Temperature: -4 ~ 122°F (-20 ~ 50°C)
- Storage Temperature: -40 ~ 158° (-40 ~ 70°C)
- Optional Built-in Smart Card Reader
- Dimensions: 7.48 in (W) x 3.54 in (D) x 0.47 in (H) /  
190 mm (W) x 90 mm (D) x 12 mm (H)
- Weight: .37 lb (170 g)



## Stand Unit

Stand unit can hold the system unit and Docklight with adjustable view angle. It can be used in office or in vehicle.

There are 2 configuration options:

- Stand unit only to accept system unit.
- Stand unit with Docklight hooked to accept system unit.



### Mount Stand Unit

1. Open the rubber cap on the docking connector.
2. Align the computer into stand unit.
3. Push the lever to engage and fix.
4. Lock the computer.

**Note:**

- *Same as DK8 Stand Unit*



# Chapter 8 – Maintenance and Service

## Cleaning

ALWAYS turn OFF the power, unplug the power cord and remove the battery before cleaning.

The exterior of the system and display may be wiped with a clean, soft, and lint-free cloth. If there is difficulty removing dirt, apply non-ammonia, non-alcohol based glass cleaner to the cloth and wipe.

An air gun is recommended for cleaning water and dust. For salty water please clean with fresh water then blow-dry with an air gun.

## Troubleshooting

Should the tablet computer fail to function properly, the troubleshooting steps below may be followed.

- Power Problems:

**When I turn on the Tablet computer, it does not respond.**

- If you are using battery power, check if the battery is charged
- If you are using AC power, ensure that the connection of AC adapter is correct.

**I cannot return from Hibernation while on battery power**

- The battery might be drained. Please plug the tablet into AC power.
- Hard reset the device by pressing the power button for 4 seconds

**Unexpected or improper shutdown causes BIOS to reset to Optimized Default**

- This could be a power problem. Please connect the AC power adapter to fix the abnormal shutdown problem.

- Minimize the configuration, i.e. remove extra peripherals and devices.
- Remove the modules one by one (HDD, Battery, etc.).
- Remove the software suspected.
- Set BIOS fail-safe default.
- Re-install operating system and application software.

## RMA Service

If troubleshooting solutions are unsuccessful, consult your dealer for RMA.

Shipping instructions:

1. Remove any personal add-on devices or other media.
2. Use the original shipping container and packing materials, if possible.
3. If the original packing materials are not available, wrap the equipment with soft material (e.g. PU/PE form) then put the wrapped equipment into a hard cardboard shipping box.
4. Include a sheet with the following information: (Note: Please keep a copy of this sheet for your records.)
  - Name
  - Address
  - Unit serial number
  - Place and date of purchase or the original invoice number
  - Date of failure
  - A DETAILED description of the problems you have encountered including: The operating system, the add-on device installed (if any), the application software, the failure phenomenon, etc.
  - A list of the hardware/software configuration, if applicable.
5. Clearly mark the outside of the shipping box with the RMA #. If an RMA # is not present on the shipping box, receiving will be unable to identify it and it might be returned.
6. Unless prior arrangements have been made, the customer is responsible for all shipping costs. Unauthorized use of the company's shipping accounts is not permitted.

If you require support please contact AMREL Service department:

**Phone:** 800.882.6735

**E-mail:** [cdinfo@amrel.com](mailto:cdinfo@amrel.com)